

®

AYDE

CAM BALKON PROFİLLERİ

GLASS BALCONY PROFILES

50129

1,990 kg / mt

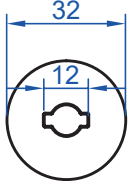

50130

1,398 kg / mt

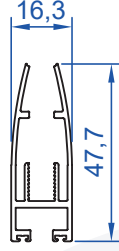

50131

1,599 kg / mt

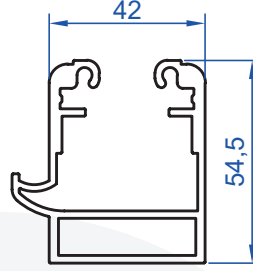

50132

1,906 kg / mt

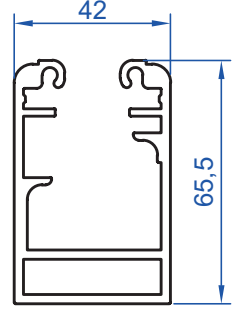

50133

1,323 kg / mt

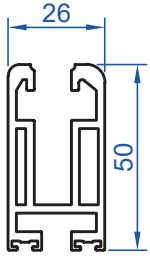

50134

0,466 kg / mt

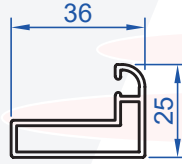

50135

0,940 kg / mt

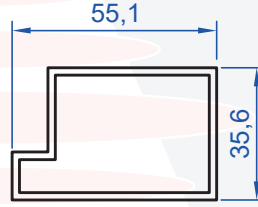

50384

0,400 kg / mt

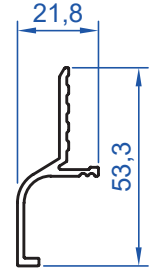

50386

0,673 kg / mt

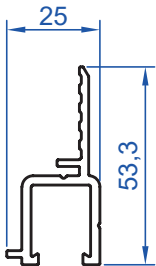

50387

2,173 kg / mt

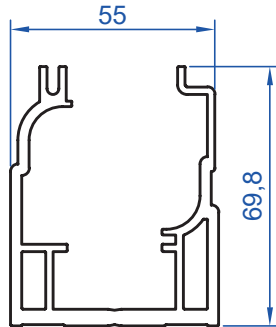

70022

1,832 kg / mt

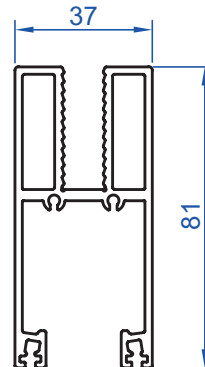

70028

2,424 kg / mt

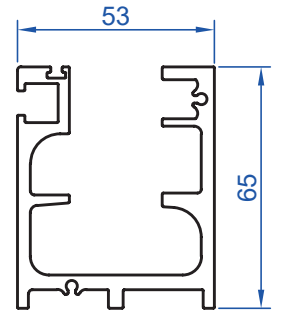

50538

1,428 kg / mt

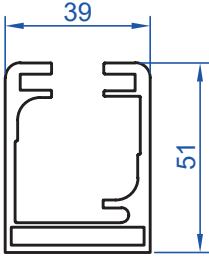

50560

0,981 kg / mt

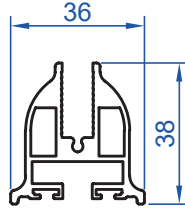

50561

1,048 kg / mt

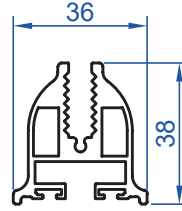

50600

0,980 kg / mt

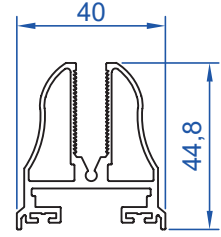

50601

1,533 kg / mt

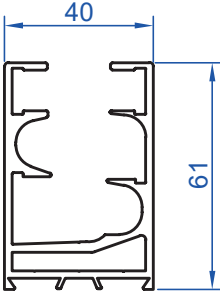

50602

0,868 kg / mt

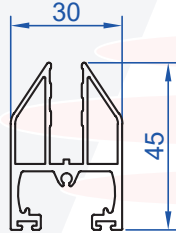

50603

0,734 kg / mt

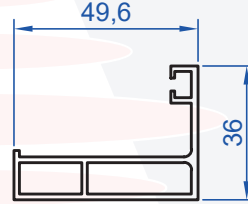

50604

1,482 kg / mt

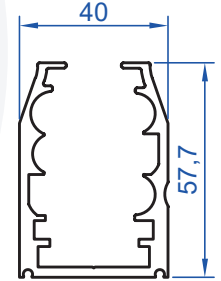

50756

1,430 kg / mt

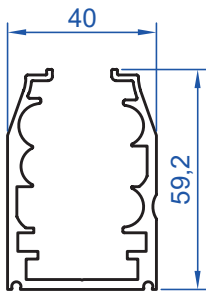

33000

0,586 kg / mt

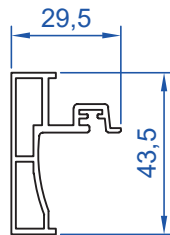

33001

0,184 kg / mt

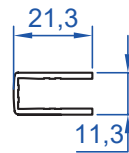

33002

0,560 kg / mt

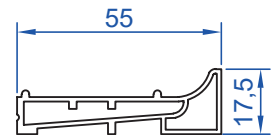

50612

1,069 kg / mt

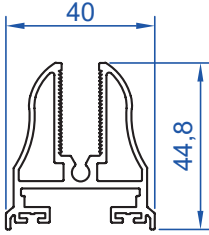

50613

0,462 kg / mt

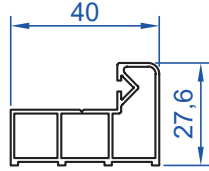

50627

0,479 kg / mt

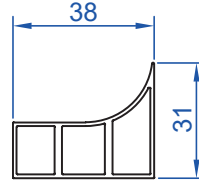

50628

0,363 kg / mt

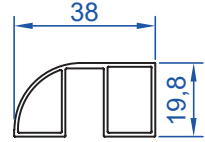

50629

1,055 kg / mt

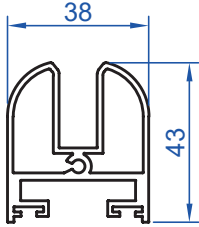

50630

1,829 kg / mt

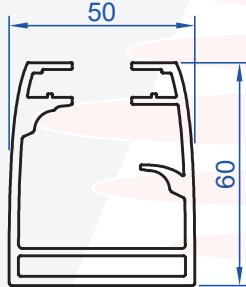

50640

0,882 kg / mt

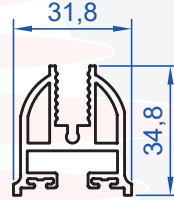

50704

1,021 kg / mt

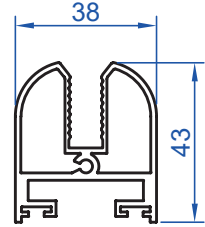

50715

0,935 kg / mt

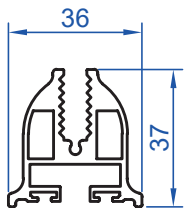

50724

2,424 kg / mt

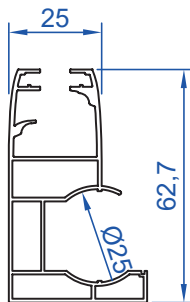

50751

1,428 kg / mt

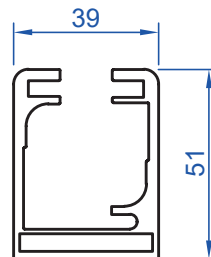

50762

1,457 kg / mt

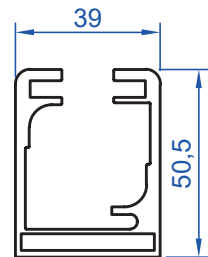

51032

0,945 kg / mt

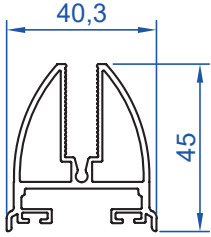

51033

0,537 kg / mt

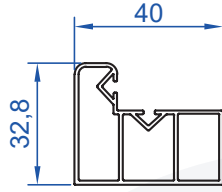

51034

1,582 kg / mt

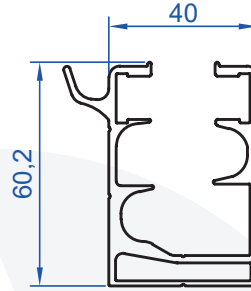

51035

1,089 kg / mt

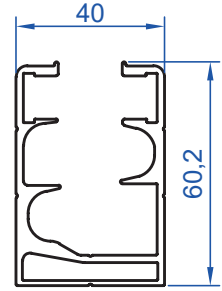

51036

1,342 kg / mt

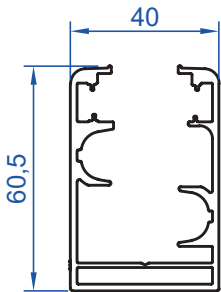

51037

1,020 kg / mt

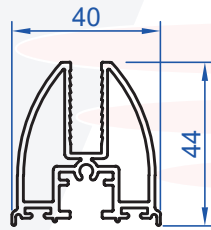

51038

0,392 kg / mt

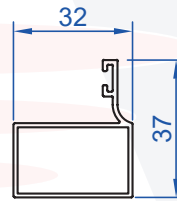

51067

1,443 kg / mt

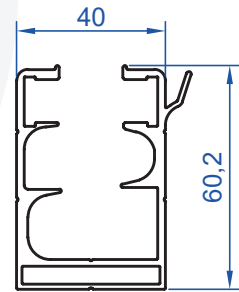

51068

0,457 kg / mt

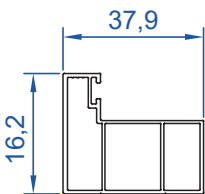

51315

1,346 kg / mt

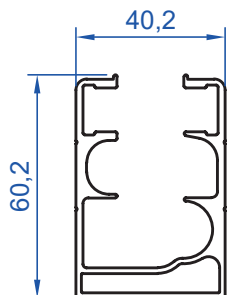

51316

0,853 kg / mt

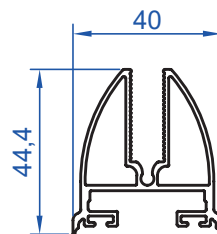

51317

0,550 kg / mt

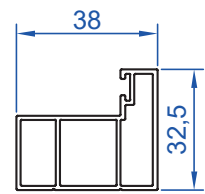

51226

1,499 kg / mt

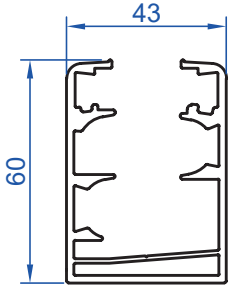

51227

0,853 kg / mt

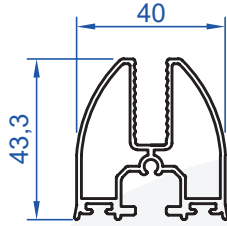

51366

1,632 kg / mt

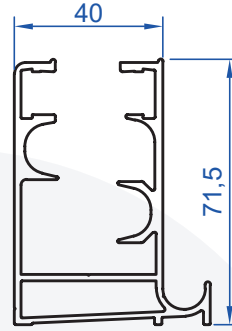

51367

1,236 kg / mt

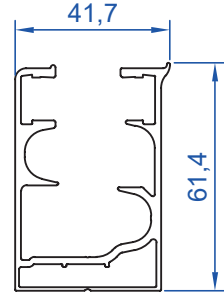

51368

0,756 kg / mt

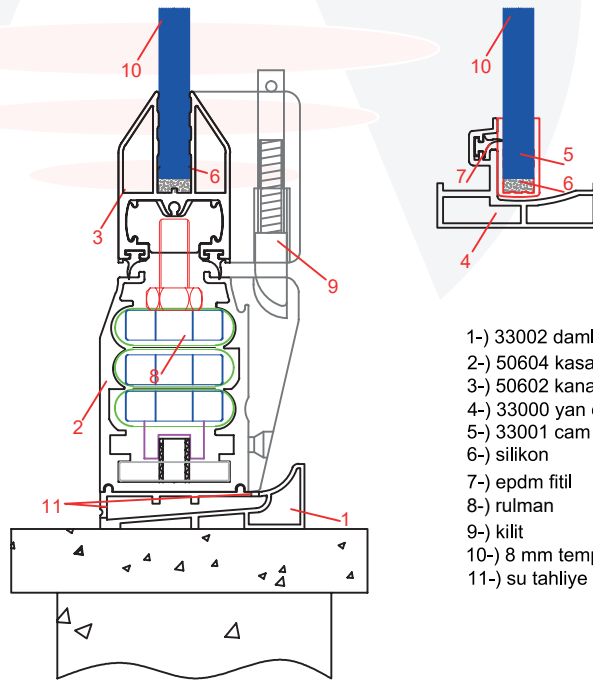
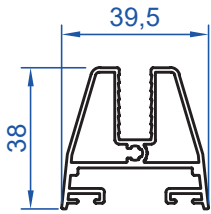

- 1-) 33002 damlalık profili
- 2-) 50604 kasa profili
- 3-) 50602 kanat profili
- 4-) 33000 yan dikme profili
- 5-) 33001 cam bitiş profili
- 6-) silikon
- 7-) epdm fitil
- 8-) rulman
- 9-) kilit
- 10-) 8 mm temperli cam
- 11-) su tahliye deliği

CORNERGLAS MARKA ÜRÜNLERİMİZ TPE :2010 03253 PATENT NOSUYLA KORUMA ALTINDADIR.